

Inter-Operation of Interface Standards

National Semiconductor
Application Note 972
J. Goldie
November 1994



Introduction

When communication is required between systems that support *different* interfaces is required, a detailed study of driver output and receiver input characteristics is required to determine if direct “electrical” inter-operation is possible. The results of this study may also conclude that some translation devices are required for inter-operation. This may include passive devices or active devices, and even perhaps a repeater circuit. This application note focuses on the simplest way to gain electrical inter-operation between devices conforming to different Interface standards. Compatibility of various protocol and mechanical dimensions of connectors is beyond the scope of this application note, but must also be investigated to determine if inter-operation is possible. The following cases are covered, along with a discussion on important electrical characteristics of standard drivers and receivers.

- **Single-ended to Differential**
RS-232 to RS-422
TTL to RS-422
- **Differential to Single-ended**
RS-422 to RS-232 (unipolar)
RS-422 to RS-232 (polar)
RS-422 to TTL
RS-485 to TTL
- **Single-ended to Single-ended**
TTL to RS-232
RS-232 to TTL
- **Differential to Differential**
ECL to RS-422
RS-422 to RS-485

Driver Output and Receiver Input Characteristics

Before any connection is made, a careful review of the driver output electrical characteristics, and the receiver input electrical characteristics should be completed. For the driver, the following parameters should be reviewed: driver output levels (minimum and maximum), and typical driver loading. For the receiver, the following parameters should be reviewed: input thresholds (sensitivity), input voltage range, and input resistance. Once these parameters have been reviewed, a decision upon what intermediate circuitry between the driver and receiver is required if any. The following pairs of param-

eters should be compared to determine if they are directly compatible: driver load to receiver input resistance, driver output levels to receiver input voltage range, and driver output levels to receiver thresholds.

Case One: Single-Ended to Differential

When interfacing a single-ended driver to a differential receiver it is important to establish that the maximum output voltage of the single-ended driver does not exceed the recommended input voltage rating of the differential receiver. If it does not, then a direct connection is possible from a maximum voltage level point of view. If it does a simple resistor voltage divider should be inserted to attenuate the signal down to acceptable levels. A second check must be done to make sure that the minimum driver level, after the divider network if employed, is still greater than the receiver's sensitivity. The divider network, should be selected such that the total load presented to the driver is that of a single-ended receiver. Two examples are provided.

RS-232 to RS-422

Depending upon the RS-232 driver that has been specified, driver output levels may be as high as $\pm 15V$, and for some RS-422 receivers the maximum input range is specified at $\pm 10V$. For this case, a divider network is required. A simple $3\text{ k}\Omega$ in series with a $2\text{ k}\Omega$ will provide the required attenuation and the correct load. It attenuates the signal 40%, dropping the $\pm 15V$ to $\pm 9V$ on the high side, and $\pm 5V$ (driver minimum output level) to $\pm 3V$ (which is greater than the receivers thresholds of $\pm 200\text{ mV}$). In addition the RS-232 driver also sees a $5\text{ k}\Omega$ load of the divider network as it should. If the RS-422 receivers can withstand a $\pm 15V$ input signal, the attenuator circuit is not required from a voltage level point perspective, but may still be desirable. This is due to the fact that many RS-422 (or RS-485) receiver's input impedance is in the range of $18\text{ k}\Omega$, which would cause a faster driver transition time and possibly an EMI and or crosstalk issue. *Figure 1* illustrates inter-operation between the RS-232 driver with a divider network to a RS-422 differential receiver. Note, that one receiver input is referenced to ground. Depending upon the input referenced to ground, a logic NOT may be achieved by tying the + input to ground, and connection to the divider network with the - input. Historically, this divider network has been termed an L-Pad in TIA/EIA documents and other international standards.

RS-232 to RS-422 (Continued)

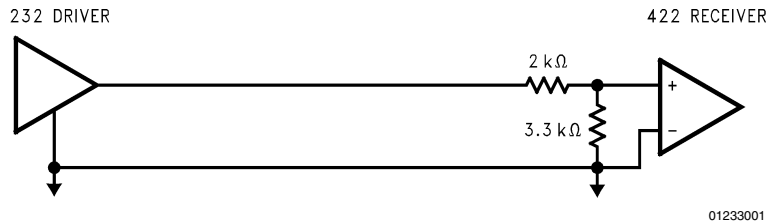

FIGURE 1. RS-232 to RS-422

TTL to RS-422

Since differential receivers are basically modified comparators, they detect logical states by the difference in potential between their input pins, not with respect to circuit ground. Due to this fact, they can also accept standard TTL or CMOS levels if the other input is appropriately referenced. For TTL levels, one input should be tied to +1.5V, and the resulting thresholds will be +1.7V, and +1.3V. In other words, any levels greater than or equal to +1.7V will be a logic HIGH, and any level less than or equal to +1.3V a LOW, if the reference voltage was applied to the – input. Receivers normally have internal references between +2V and +3V, but it is not recommended that you float the reference input and rely on the internal reference due to the following reasons. First, the internal reference voltage is not normally specified in a datasheet, thus tolerances are not guaranteed or supported. Secondly, the input is a high impedance input, and depending upon the environment, it may pick up external noise and shift the thresholds around. A voltage regulator, or a simple resistor divider may be used depending upon the accuracy required. If a resistor divider is used, remember to take into account the input impedance of the receiver, which can be model (1st level) as a resistor to the internal bias voltage. These two values may be measured with a curve tracer. By sweeping voltage on the reference input, the resulting slope of the line (V_{IN} vs. I_{IN}) is the input impedance, and the crossing of the X axis is the zero current point or internal reference voltage. Note, that this test must be done with the receiver powered up to measure the reference voltage. *Figure 2* illustrates the inter-operation between standard TTL logic and a differential RS-422 receiver.

Case Two: Differential to Single-Ended

Differential to single-ended poses a more difficult problem to solve. Since single-ended receivers, RS-232 for example,

essentially detect positive or negative voltage with respect to ground, an active solution is required to gain inter-operation with a single supply differential drivers. The following cases are provided as examples.

RS-422 to RS-232

RS-422 drivers (unipolar) are commonly powered from a single +5V power supply, thus both output states are positive voltages (V_{OL} and V_{OH}). RS-232 receivers as discussed detect positive and negative voltages, therefore to obtain inter-operation the circuit illustrated in *Figure 3* can be used. The PNP transistor is used as a switch, that when it is ON, the receiver input voltage is basically a $V_{CE(SAT)}$ below the driver's V_{OH} level. This is typically greater than +3V, and is a valid RS-232 input level. When the driver is in the opposite state, the PNP is off, the receiver input is pulled to ground by its internal input resistor. Note, RS-232 specifies the receiver thresholds are between –3V and +3V, however most receiver support TTL like thresholds centered around +1.5V, and guarantee a failsafe HIGH output state for an open input state (pulled low by internal input resistor). In the circuit shown in *Figure 3*, the resistor (R1) limits the base current and prevents the PNP from entering deep saturation, the diode (D1) prevents break down of the emitter base junction when the PNP is off. An additional resistor (R2) may be inserted to pull the RS-232 input to a voltage (below –3V) if required, but this also requires a negative supply and is typically not necessary. *Figure 3* illustrates this case of inter-operation.

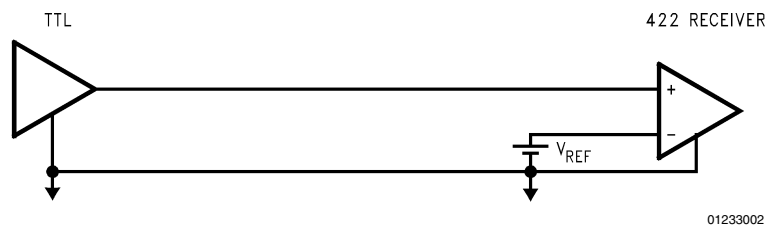

FIGURE 2. TTL to RS-422

RS-422 to RS-232 (Continued)

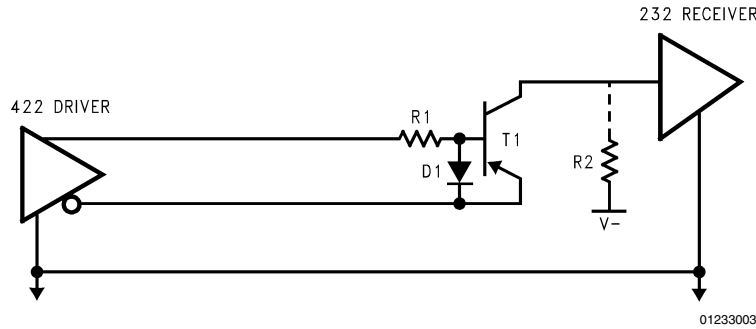

FIGURE 3. RS-422 to RS-232 — with Active Device

However, this active circuitry may not be required if the two systems share the same ground reference, are located close together, are in a relatively noise free environment and the RS-232 receiver provides a TTL threshold. This is due to the fact that RS-422 driver output levels are quite similar to standard TTL levels, however, driver output curves should be consulted to determine that the drivers V_{OH} level will be detected by the RS-232 receiver as a valid V_{IH} , and the V_{OL} as a V_{IL} respectively. These output levels can be determined by superimposing a 5 k Ω load line over the driver V_{OH}/I_{OH} curve. If the resulting driver V_{OH} is greater than the receiver's V_{IH} , then inter-operation is possible. Similarly the output low case should be checked. RS-422 drivers are voltage mode drivers, and both outputs are not required to inter-operate with the single-ended receiver. Therefore, select the output which provides the desired logic (true or inverting), and leave the other output "open". Do not tie the unused output to ground, as that could yield an output short circuit condition (I_{OS}) which is undesirable from a power dissipation consideration. Figure 4 illustrates the direct connection example.

RS-422 to RS-232

RS-422 drivers are also available that are powered from polar ($\pm 5V$) power supplies. If this is the case then once

again a direct connection to a RS-232 receiver is possible. This is possible since the V_{OH} of the driver is typically between +3V and V_{CC} , while the V_{OL} of the driver is between -3V and V_{EE} , in both the output levels are greater in magnitude than the RS-232 receivers thresholds. Figure 5 illustrates this second case of direct inter-operation.

RS-422 to TTL

As discussed above, RS-422 driver output levels are quite similar to standard TTL levels, however, driver output curves should be consulted to determine that the drivers V_{OH} level will be detected by the TTL input as a valid V_{IH} , and the V_{OL} as a V_{IL} respectively. In almost all cases a direct connection will be possible. RS-422 drivers are voltage mode drivers, and both outputs need not be used. Simply pick the output (true or inverting), and leave the other output "open". Do not tie the unused output to ground, as that could yield an output short circuit condition (I_{OS}) which is undesirable from a power dissipation consideration. Figure 6 illustrates the inter-operation of a RS-422 driver with a standard TTL input.

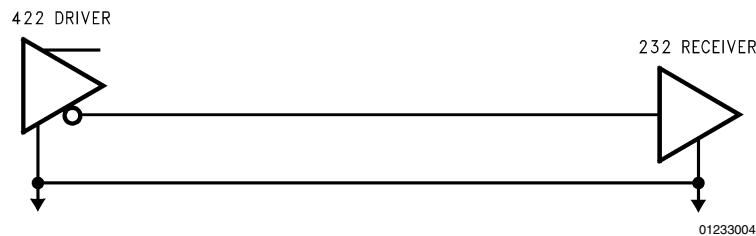

FIGURE 4. RS-422 to RS-232 — Direct Connection

RS-422 to TTL (Continued)

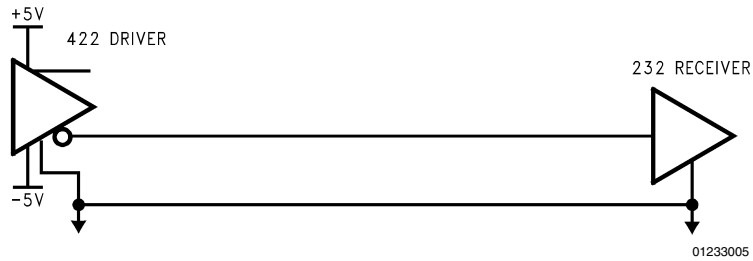

FIGURE 5. RS-422 to RS-232

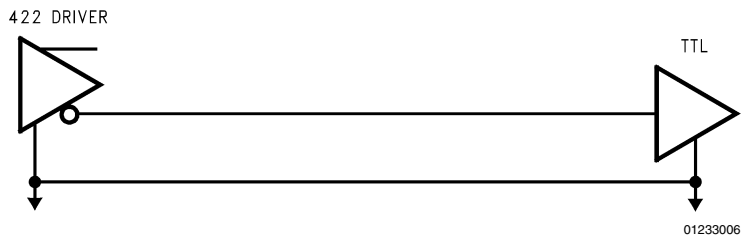

FIGURE 6. RS-422 to TTL

RS-485 to TTL

RS-485 driver output levels are NOT similar to standard TTL levels, however, direct inter-operation may be possible. Again, driver output curves should be consulted to determine that the drivers V_{OH} level will be detected by the TTL input as a valid V_{IH} , and the V_{OL} as a V_{IL} respectively. Since the RS-485 outputs include blocking diodes, the V_{OH} levels are lower than standard TTL levels, and the V_{OL} levels are a diode higher than standard levels. Once again, RS-485 drivers are voltage mode drivers, and both outputs need not be used. Simply select the desired output (true or inverting), and leave the other output "open". Do not tie the unused output to ground, as that could yield an output short circuit condition (I_{OS}) which is undesirable from a power dissipation consideration. If the driver output levels do not meet the TTL input V_{IH} and V_{IL} specifications, a RS-485 receiver should be used to receive the RS-485 levels and correctly translate them to TTL compatible levels. *Figure 7* illustrates this connection.

Case Three: Single-Ended To Single-Ended

Single-ended to Single-ended is once again simply comparing output levels to thresholds and input voltage ranges. In some cases, a direct connection is possible, as described in the following examples.

TTL to RS-232

TTL output levels can directly inter-operate with certain RS-232 receivers. This is true since most RS-232 receivers support a tighter threshold specification than required by the RS-232 standard. The RS-232 standard specifies that the thresholds are between +3V and -3V, however, most thresholds are centered around +1.5V. If this is the case, then standard TTL levels (High > 2.0V and Low < 0.8V) will be detected correctly. One note of caution is that the TTL gate will be loaded with the 5 k Ω load instead of a standard TTL input load. The TTL gate driving the RS-232 receiver must have adequate drive capability to obtain the correct levels with the RS-232 receiver load. This connection is illustrated in *Figure 8*.

RS-232 to TTL

RS-232 output levels are polar, and therefore they swing around ground. This negative swing typically prevents direct inter-operation to TTL inputs which prefer positive voltages only. To clamp off the negative swing a diode may be used to clip the negative swing but will load down the driver when the diode is forward biased. This is typically acceptable if the driver employed provides a relatively tight current limit in the range of 10 mA. *Figure 9* illustrates this inter-operation with a diode clamp.

RS-232 to TTL (Continued)

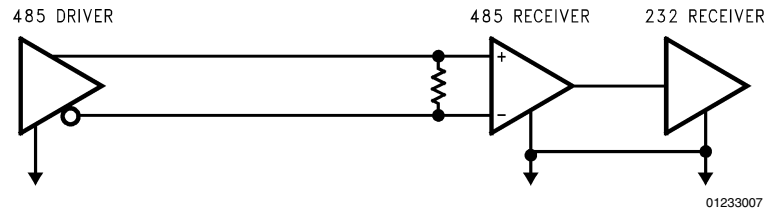

FIGURE 7. RS-485 to TTL

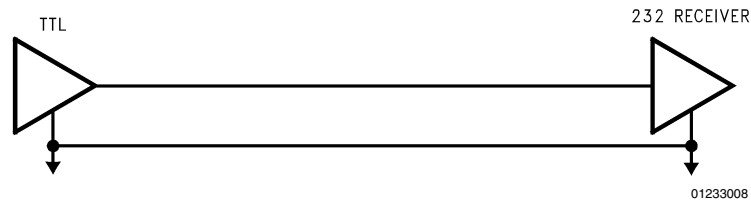

FIGURE 8. TTL to RS-232

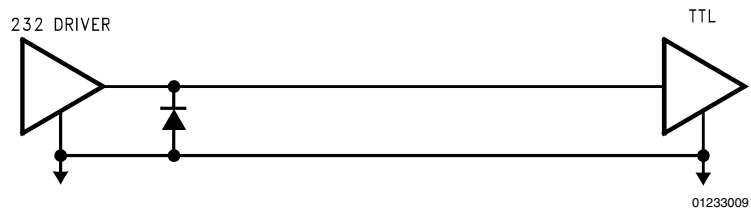

FIGURE 9. RS-232 to TTL

Case Four: Differential to Differential

As in the other three cases described, driver output levels need to be compared to receiver input thresholds and input voltage ranges. If they agree, then a direct connection is possible. If the levels are not compatible then a repeater/translator circuit will be required.

ECL to RS-422

Differential ECL or even Pseudo ECL (PECL) will typically directly inter-operate with a RS-422 receiver. This is possible since a RS-422 receiver provides a tight threshold specification of ± 200 mV, and a wide common mode range of ± 10 V. Differential ECL output levels are normally between ± 500 mV to ± 800 mV which are detectable by the receiver. Since the receiver supports a positive and negative common mode range ECL or PECL signals may be received. *Figure 10* illustrates a ECL to RS-422 (or RS-485) connection.

RS-422 to RS-485

Direct connection of RS-422 to RS-485 is always possible. RS-485 can be considered a subset of RS-422 which supports multipoint (multiple drivers) applications. RS-422 and RS-485 receivers are virtually identical, except for the fact that the RS-485 receiver present a input impedance that is typically 3 times the RS-422 receiver. For this reason, the RS-422 driver can now drive at least 32 receiver loads

opposed to the RS-422 limit of 10. Recall that RS-422 is limited to single driver/multiple receiver applications, and only RS-485 devices (drivers) should be employed in true multipoint (multiple driver) applications. *Figure 11* illustrates a RS-422 driver driving up to 32 RS-485 receivers in a multidrop uni-directional application.

Summary

In many cases direct inter-operation is possible between different interface standards. In cases where that is not possible, typically simple circuitry can be inserted between the two devices to alter or clamp the levels to levels that are compatible with the other device. In the extreme case, where simple circuitry can not solve the problem, a repeater may be used. For example, if an "A" driver needs to inter-operate with a "B" receiver, a repeater may be inserted between the two that includes a "A" receiver and a "B" driver. For example, this may be desirable for interfacing a RS-422 driver to a ECL differential receiver since most ECL receivers can not accept positive (above ground) input voltages. This method should be a solution of last resort due to the added cost of the active devices, and the repeater itself. The methods described above are preferred, as they provide direct, or inter-operation with only simple circuitry. As a final word of caution, always review the respective device specifications to determine if inter-operation is possible before connecting the two together.

Summary (Continued)

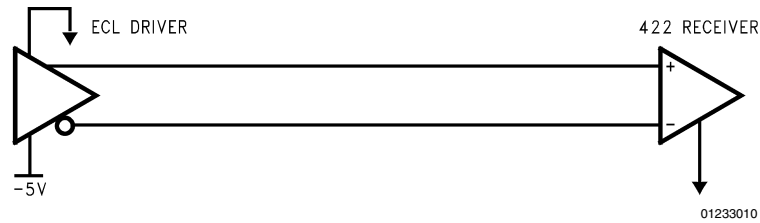

FIGURE 10. ECL to RS-422

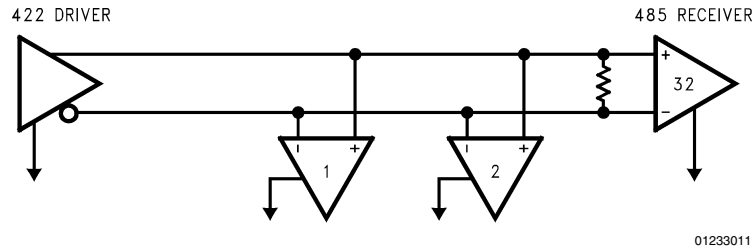

FIGURE 11. RS-422 to RS-485

Table 1 lists key generic electrical characteristics of common interface standards.

TABLE 1. Electrical Characteristics Comparison of Common Interface Standards

Parameter	RS-232	RS-422	RS-423	RS-485
Maximum Driver Output Level	$\pm 25V$ No Load $\pm 15V$ 7 k Ω Load	$\pm 10V$ No Load $\pm 6V$ Diff.	$\pm 6V$ No Load	$\pm 6V$ No Load $\pm 6V$ Diff.
Minimum Driver Output Level	$\pm 5V$ 3 k Ω Load	$\pm 2V$ 100 Ω Load	$\pm 3.6V$ 450 Ω Load	$\pm 1.5V$ 54 Ω Load
Standard Driver Load	3 k Ω –7 k Ω 5 k Ω Typical	100 Ω	>4 k Ω Typical 450 Ω Minimum	54 Ω
Receiver Input Voltage Range	$\pm 15V$	$\pm 10V$	$\pm 10V$	$\pm 10V$
Receiver Thresholds	$\pm 3V$ +1.5V Typical	$\pm 0.2V$	$\pm 0.2V$	$\pm 0.2V$
Receiver Input Impedance	3 k Ω –7 k Ω 5 k Ω Typical	≥ 4 k Ω	≥ 4 k Ω	$\sim > 12$ k Ω
MODE	Single Ended	Differential	Single Ended	Differential

References

EIA/TIA Standard EIA/TIA-232-E, Interface Between Data Terminal Equipment and Data Circuit-Terminating Equipment Employing Serial Binary Data interchange, EIA/TIA, Washington, D.C.

TIA/EIA Standard TIA/EIA-422-B, Electrical Characteristics of Balanced Voltage Digital Interface Circuits, TIA, Washington, D.C.

TIA/EIA Standard TIA/EIA-423-B, Electrical Characteristics of Unbalanced Voltage Digital Interface Circuits, TIA, Washington, D.C.

EIA Standard EIA RS-485, Standard for Electrical Characteristics of Generators and Receivers for use in a Balanced Digital Multipoint Systems, EIA, Washington, D.C.

Application Note #216, Summary of Well Known Interface Standards, Interface Databook, National Semiconductor, Santa Clara, CA

Application Note #759, Comparing EIA-485 and EIA-422-A Line Drivers and receivers in Multipoint Applications, Interface Databook, National Semiconductor, Santa Clara, CA

Notes

LIFE SUPPORT POLICY

NATIONAL'S PRODUCTS ARE NOT AUTHORIZED FOR USE AS CRITICAL COMPONENTS IN LIFE SUPPORT DEVICES OR SYSTEMS WITHOUT THE EXPRESS WRITTEN APPROVAL OF THE PRESIDENT AND GENERAL COUNSEL OF NATIONAL SEMICONDUCTOR CORPORATION. As used herein:

1. Life support devices or systems are devices or systems which, (a) are intended for surgical implant into the body, or (b) support or sustain life, and whose failure to perform when properly used in accordance with instructions for use provided in the labeling, can be reasonably expected to result in a significant injury to the user.
2. A critical component is any component of a life support device or system whose failure to perform can be reasonably expected to cause the failure of the life support device or system, or to affect its safety or effectiveness.



National Semiconductor Corporation
Americas
Email: support@nsc.com

www.national.com

National Semiconductor Europe

Fax: +49 (0) 180-530 85 86
Email: europe.support@nsc.com
Deutsch Tel: +49 (0) 69 9508 6208
English Tel: +44 (0) 870 24 0 2171
Français Tel: +33 (0) 1 41 91 8790

National Semiconductor Asia Pacific Customer Response Group

Tel: 65-2544466
Fax: 65-2504466
Email: ap.support@nsc.com

National Semiconductor Japan Ltd.

Tel: 81-3-5639-7560
Fax: 81-3-5639-7507